

DEFINOX - DCX 3 & DCX 4 MINI

Manual & Pneumatic

DE-NU012F11100

DCX3 mini, 1/2" L-body, Manual, PEEK/EPDM

- High packing pressure
- Independent and compact body
- Many configuration options
- Possible use on a wide range of applications

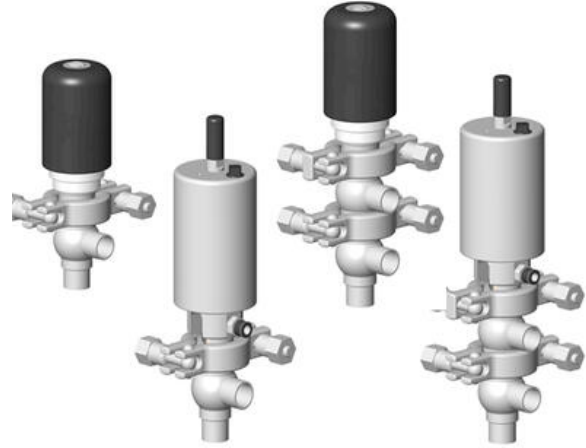

PRODUCT DESCRIPTION

Definox Mini Seat Valves.

This seat valve design offers a wide range of options and variants.

Technical advantages:

- From 1/2" to 1"
- Fitted with PEEK plug as standard - inert to chemical products
- Welded or Clamp ends possible
- Ergonomic handle with visual opening indicator
- Elastomer seal available for charged products
- High packing pressure
- Self-contained and compact body with a wide range of configuration options:
- Possible use on a wide range of applications
- Easy and fast maintenance thanks to the clamp assembly

TECHNICAL DATA

Certificate	3.1 EN10204
Connection type	Weld ends
Description	PEEK PLUG
Housing	L Body
Housing	EPDM
Inner diameter	9.4 mm
Material quality	1.4404
Operating pressure max	18 bar
Outer diameter	12.7 mm
Surface finish	Indv.: RA 0,8µm Udv.: 1,2µm
Temperature operational max	140 °C

Temperature operational min	-5 °C
Weight	0.6 kg

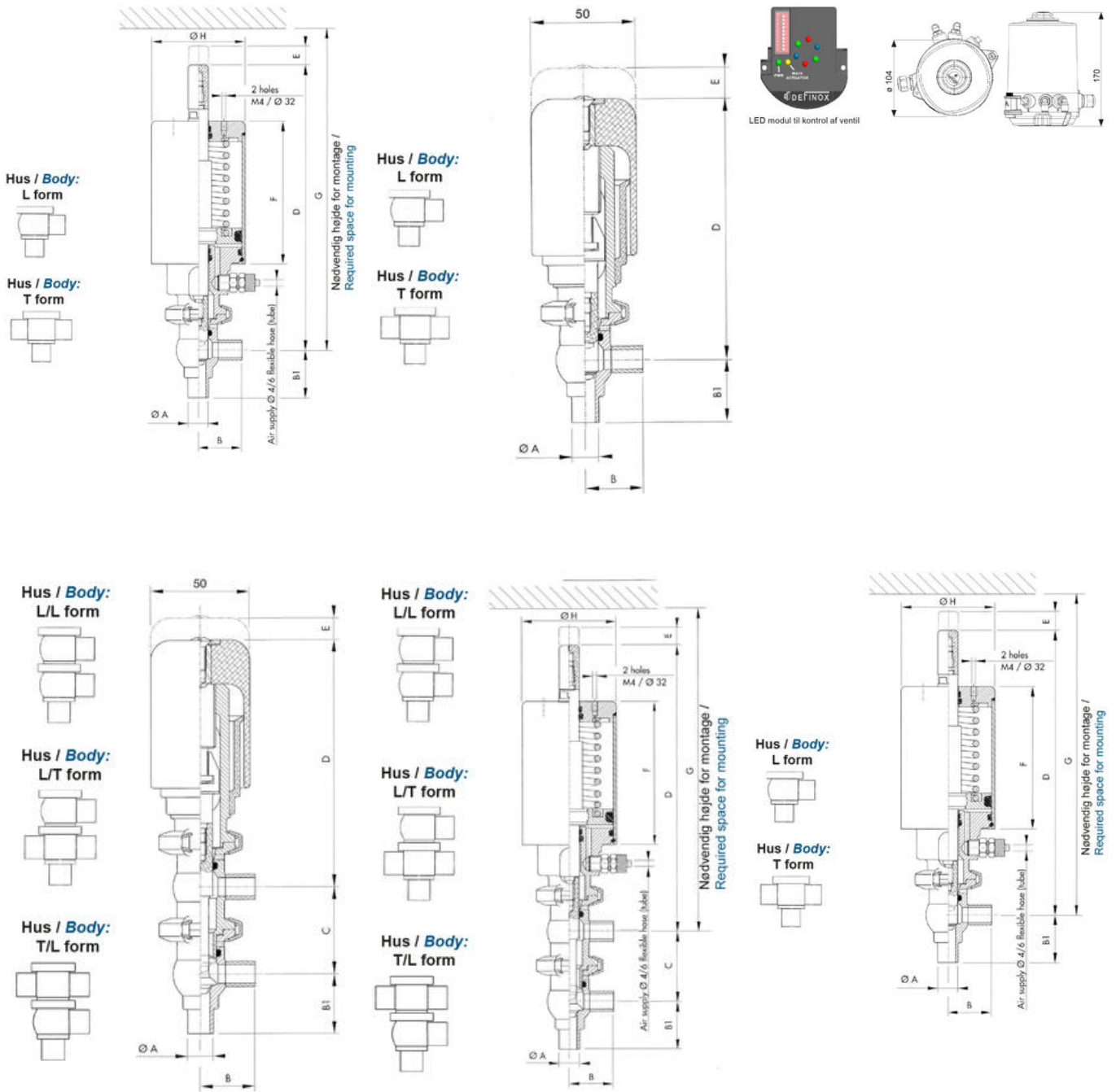

Hus / Body:
L form



Hus / Body:
T form

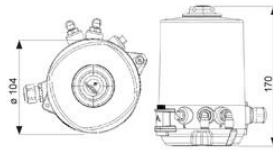
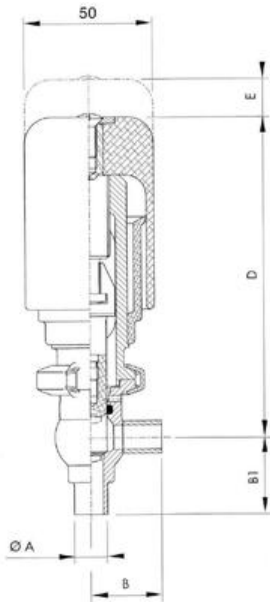

Hus / Body:
L/L form

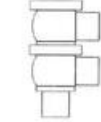

Hus / Body:
L/T form



Hus / Body:
T/L form

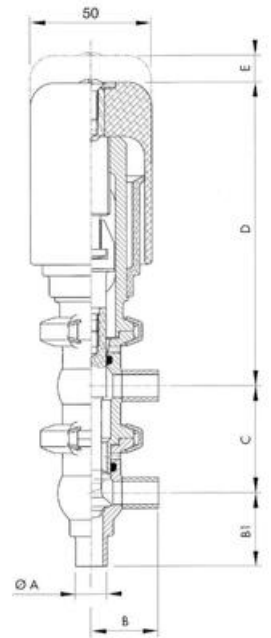
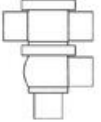

Hus / Body:
L/L form



Hus / Body:
L/T form

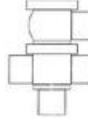

Hus / Body:
T/L form

