

## KUEBLER - WIRE ENCODERS C120

### SERIE D8.XC1

- Measurement length 6000 mm
- -20° to +85°C
- Ready speeds up to 10 m / s
- Titan-anodized aluminum housing



### PRODUCT DESCRIPTION

The Kübler wire generators are designed for demanding applications, for example within the machine building segment. The systems are robustly built with aluminum housing resistant to tough environments, they can handle high speed and have long life. The C120 series comes with analogue, incremental or absolute (SSI / BiSS, CANopen, Profibus, EtherCAT, Profinet or DeviceNet) outputs.

CE approval  
 EN 61000-6-2, EN 61000-6-3  
 ROHS approval  
 EU Guideline 2002/95 / EC

Please refer to the images below for ordering information.

Order code with encoder (incremental, absolute)				Standard variants are represented <b>bold</b> <u>underlined</u>			
D8.XC1		.0600		.XXXX		.XXXX	
a	b	c	d	e	f		
<b>a</b> <i>Mechanics</i> 2 = interchangeable installation <sup>1)</sup> 4 = fixed installation <sup>2)</sup>	<b>b</b> <i>Measuring range</i> 0600 = 6000 mm	<b>c</b> <i>Encoder used</i> 00 = <b>Sendix 5000, incremental</b> M3 = <b>Sendix M5863, absolute</b> F3 = Sendix F5863, absolute 63 = Sendix 5863, absolute M8 = <b>Sendix M5868, absolute</b> F8 = Sendix F5868 absolute 68 = Sendix 5868, absolute	<b>d</b> <i>Output circuit</i> depends on the encoder used	<b>e</b> <i>Type of connection</i> depends on the encoder used	<b>f</b> <i>Resolution / Protocol / Options</i> depends on the encoder used	<i>Optional on request</i> - Other measuring ranges - Cable diameter 1 mm - Eyelet or M4 wire fastening instead of wire clip - Modified cable and/or connector orientation - Modified cable outlet direction - Sensor protection level IP67 - Improved linearity (0.02 %)	
<b>Standard resolutions for draw wire with incremental encoder Sendix 5000</b>				<b>Standard resolutions for draw wire with absolute encoder Sendix M5863 (12 bit ST) or M5868 (12 bit ST, programmable via bus)</b>			
Drum circumference [mm]	317.68	317.68	317.68	Drum circumference [mm]	317.68		
Pulses / revolution [ppr]	1000	2000	4000	Pulses / revolution [ppr]	4096		
Pulses / mm	3.1	6.3	12.6	Pulses / mm	12.9		
Resolution [mm]	0.32	0.16	0.08	Resolution [mm]	0.08		

**Order code with encoder  
(analog, scalable with limit switch function)**

**D8.XC1.0600.M1XX.XXXX**

Standard variants are represented **bold underlined**

**a** *Mechanics*

2 = interchangeable installation <sup>1)</sup>  
4 = fixed installation <sup>2)</sup>

**b** *Measuring range*  
0600 = 6000 mm

**c** *Encoder used*  
**M1 = Sendix M5861, absolute** <sup>3)</sup>

**d** *Output circuit*

depends on the encoder used

**e** *Type of connection*

depends on the encoder used

**f** *Resolution / Protocol / Options*  
depends on the encoder used

*Optional on request*

- Other measuring ranges
- Cable diameter 1 mm
- Eyelet or M4 wire fastening instead of wire clip
- Modified cable and/or connector orientation
- Modified cable outlet direction
- Sensor protection level IP67

**Recommended standard variants (with encoder analog, scalable with limit switch function)**

Order no. draw wire encoder	Mounted encoder	Interface	Power supply	Type of connection	Resolution / Protocol	Option
D8.xC1.0600.M134.3512	Sendix M5861 (8.M5861.3534.3512)	Analog, 4 ... 20 mA	10 ... 30 V DC	radial M12 connector	12 Bit / 4 ... 20 mA	scalable with limit switch function <sup>4)</sup>
D8.xC1.0600.M144.4512	Sendix M5861 (8.M5861.3544.4512)	Analog, 0 ... 10 V	15 ... 30 V DC	radial M12 connector	12 Bit / 0 ... 10 V	scalable with limit switch function <sup>4)</sup>
D8.xC1.0600.M134.3612	Sendix M5861 (8.M5861.3534.3612)	Analog, 4 ... 20 mA	10 ... 30 V DC	radial M12 connector	12 Bit / 4 ... 20 mA	scalable without limit switch function <sup>4)</sup>
D8.xC1.0600.M144.4612	Sendix M5861 (8.M5861.3544.4612)	Analog, 0 ... 10 V	15 ... 30 V DC	radial M12 connector	12 Bit / 0 ... 10 V	scalable without limit switch function <sup>4)</sup>

**Order code with analog sensor  
(scaled to measuring range)**

**D8.3C1.0600.XXX.X.0000**

**a** *Measuring range*  
0600 = 6000 mm

**b** *Analog sensor output / power supply*

A11 = 4 ... 20 mA / 12 ... 30 V DC  
A22 = 0 ... 10 V / 12 ... 30 V DC  
A33 = potentiometer 1 kΩ / max. 30 V DC

**c** *Type of connection*

1 = axial cable, 2 m PVC  
3 = axial M12 connector, 4-pin

*Optional on request*

- Other measuring ranges
- Cable diameter 1 mm
- Eyelet or M4 wire fastening instead of wire clip
- Modified cable and/or connector orientation
- Modified cable outlet direction
- Sensor protection level IP67
- Improved linearity (0.02 %)
- Increased temperature range -40°C ... +85°C and -20°C ... +120°C

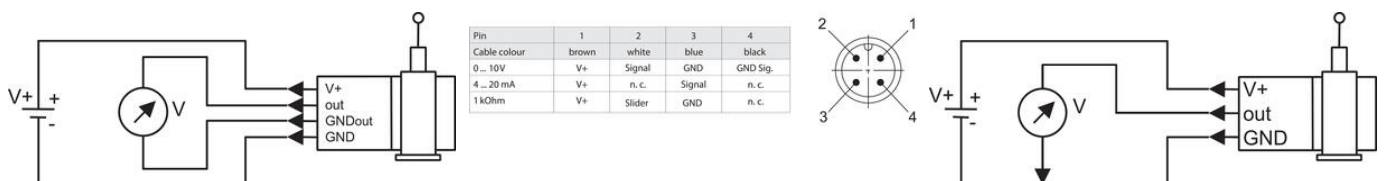
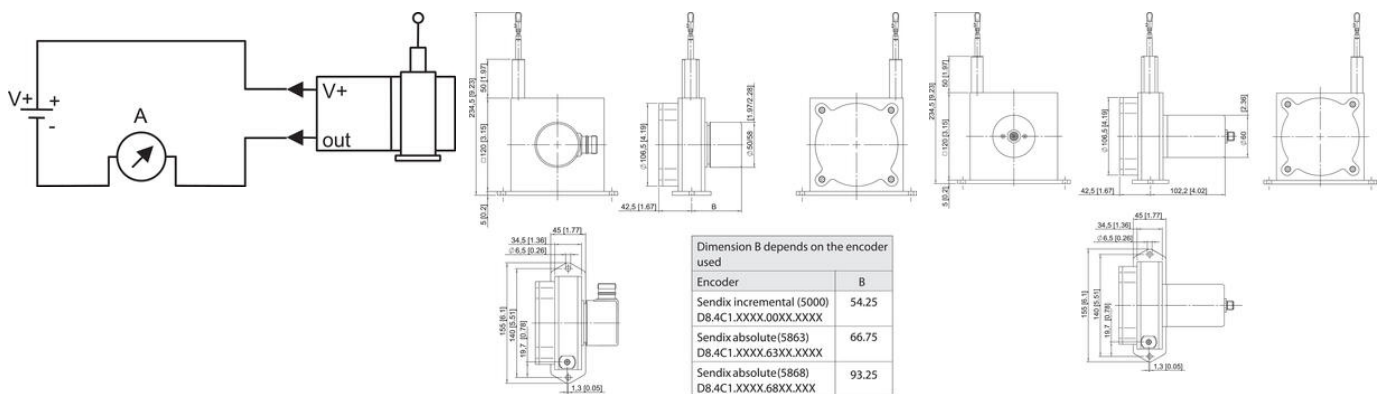
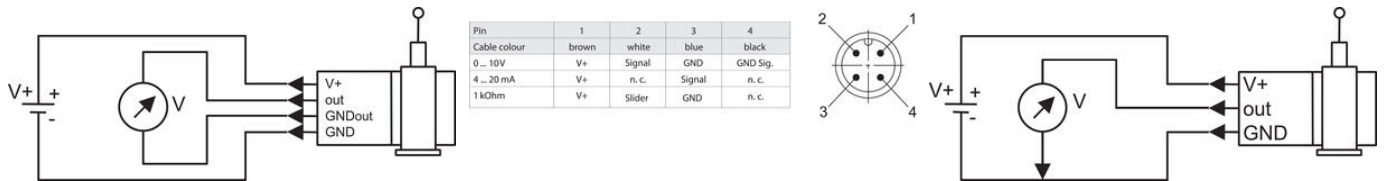

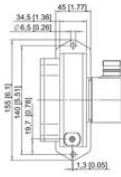
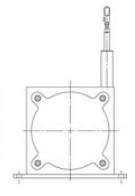
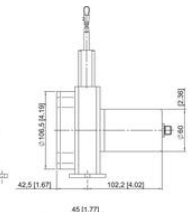
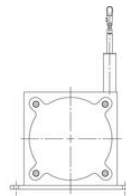
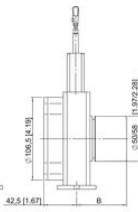
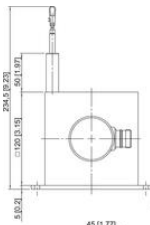
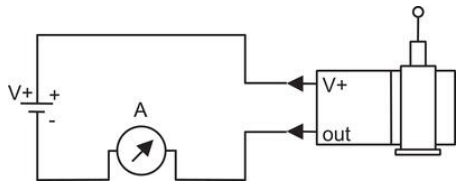

Dimension B depends on the encoder used

Encoder	B
Sendix incremental (5000) D8.4C1.XXXX.00XX.XXXX	54.25
Sendix absolute (5863) D8.4C1.XXXX.63XX.XXXX	66.75
Sendix absolute (5868) D8.4C1.XXXX.68XX.XXXX	93.25

