



IDEM SWITCH WITH IDIS-1 KEY

190057F

IDIS-1 QC M12 8way '3NC' - flat actuator

- Perfect for small covers
- 8 key entry positions
- Small dimensions
- 3 different contact configurations
- Degree of protection IP67



PRODUCT DESCRIPTION

IDIS-1 is a small and very flexible key switch, suitable for smaller flaps. Thanks to the rotating head, it has eight key entry positions. The switch is available with a flat, angled or flexible wrench. The IDIS-1 switch has a standard spacing between the mounting holes - 22 mm. As long as the key is in the switch (cover closed), the circuit breaker safety contacts are closed.

TECHNICAL DATA

Actuator	Flat
Annual usage	8 cycles per hour/24 hours per day/365 days
Approvals	ISO 14119, EN60947-5-1, EN60204-1, ISO 13849-1, EN62061, UL 508
ATEX approved	No
Conduit entry	M12 8 Pole
Contacts	3NC
Housing material	Polyester
IP class	IP67
Maximum approach / withdrawal speed	600 mm/s
Mechanical reliability B10d	2.5 x 10 ⁶ operations at 100mA load

Mounting	2 x M4
MTTFd	356 years
PFHd	3.44×10^{-8}
PL	e acc. ISO13849-1
Rated insulation voltage	600V ac
SIL	3 acc. EN62061
Thermal current (Ith)	5 A
Travel for positive opening	6 mm
Withstand voltage	2500V ac

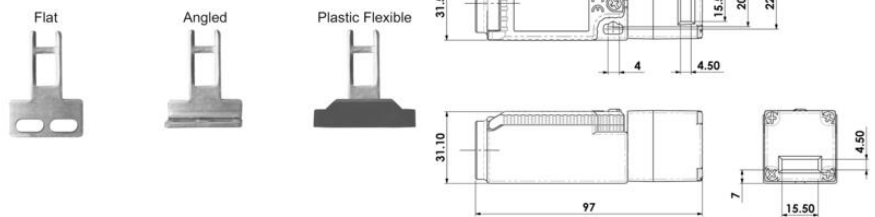
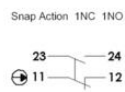
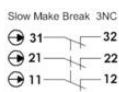
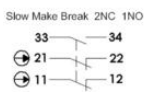
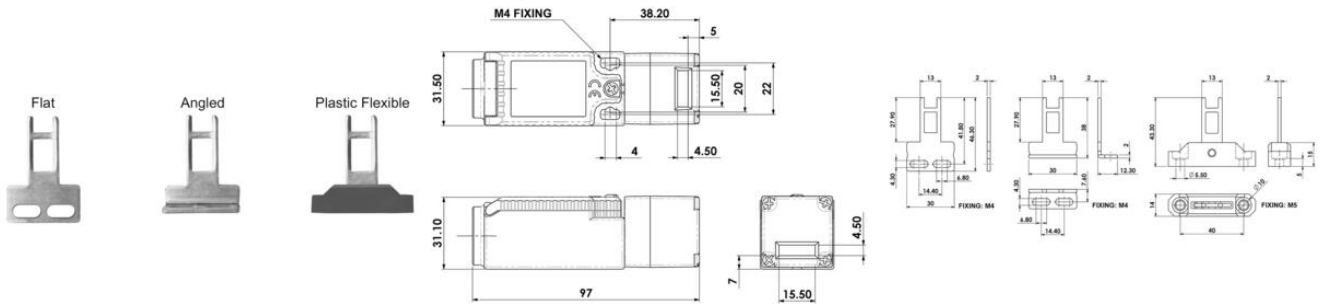

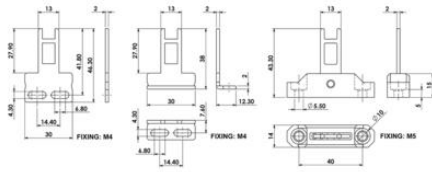

Slow Make Break 2NC 1NO

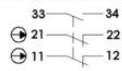

Slow Make Break 3NC

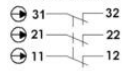

Snap Action 1NC 1NO

