

DOGA 317H - DC WIPER MOTOR WITH FEEDBACK

Right angle worm gearbox, hall sensors

317.9706.20.00

Worm gearmotor 12 V dc, 4 Nm, 25 rpm, 2.5 A, Hall Sensors

- 12 - 24Vdc with positional feedback
- Up to 4Nm
- Up to 25rpm
- Compact low noise design
- High starting torque



PRODUCT DESCRIPTION

The DOGA 317H series uses a brushed DC motor with worm gearbox and is developed to provide a compact, low noise and cost-effective solution to suit many industrial applications. Integrated with the motor are hall effect sensors offering up to 310ppr positional accuracy of the output shaft for feedback of speed, direction, and position of the rotor.

The standard hardened plastic worm wheel offers smooth, low noise operation and good performance, along with durability. IP10 is standard, with an EMC filter option.

VOLTAGE: 12 / 24Vdc supply - ideally suited to **battery powered** and **mobile applications**.

TORQUE: >4Nm nominal, >12Nm starting – a good choice for applications requiring **high start-up power**.

SPEED: 25 - 65rpm options using a range of motor/gearbox combinations.

For modest quantities DOGA can offer **product customisation** to better suit the individual needs of the customer and application. Adaptations can include changes to the output shaft, supply voltage, gear wheel material, cabling/connectors, gear ratios and motor windings.

Typical applications include:

Agriculture
Building access
Care aid
Medical
Office equipment
Marine
General industrial automation

TECHNICAL DATA

Current max	8 A
EMC filter	Yes
IP class	IP40

Max. torque	12
Nominal current	2.5 A
Nominal speed	25 rpm
Nominal torque	4
Number of pulses per revolution	310
Positioning feedback	Yes
Ratio	62:1
Shaft diameter	9 mm
Supply voltage	12 V DC
Type of gearbox	Worm
Type of wheel	Plastic
Weight	1.15 kg

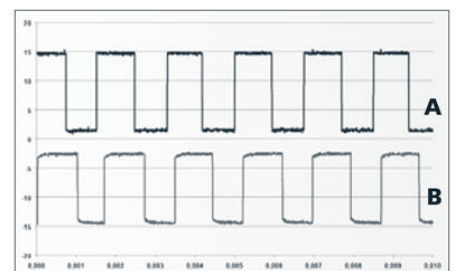
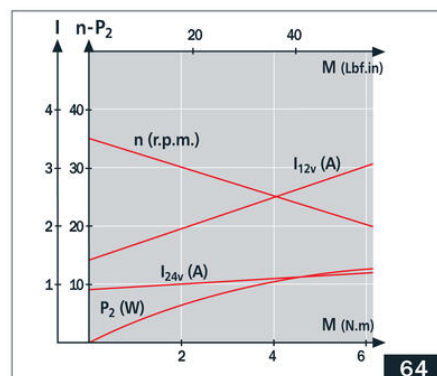
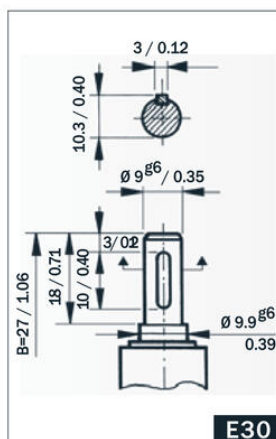
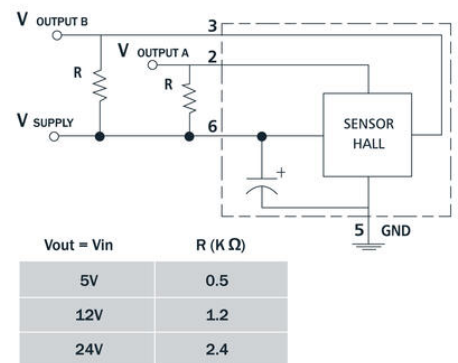
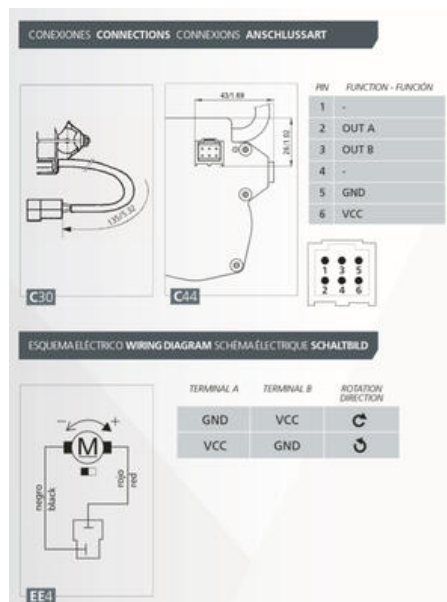
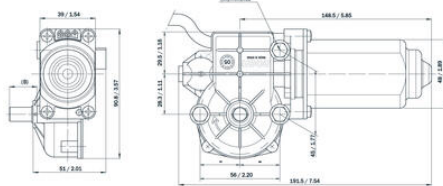

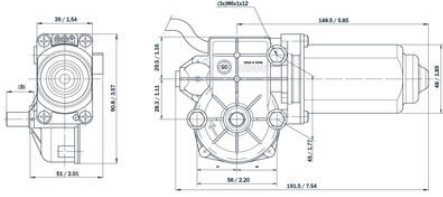

CONEXIONES CONNECTIONS CONNEXIONS ANSCHLUSSART

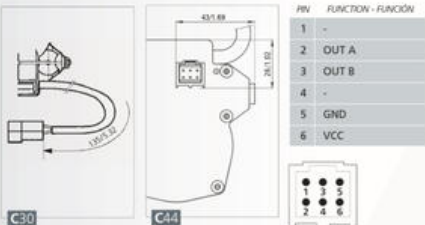

ESQUEMA ELÉCTRICO WIRING DIAGRAM SCHEMA ÉLECTRIQUE SCHALTBILD

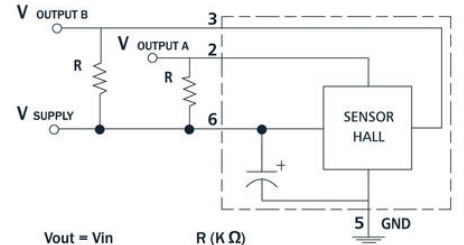
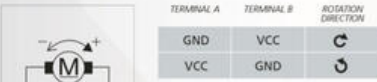

Vout = Vin	R (K Ω)
5V	0.5
12V	1.2
24V	2.4

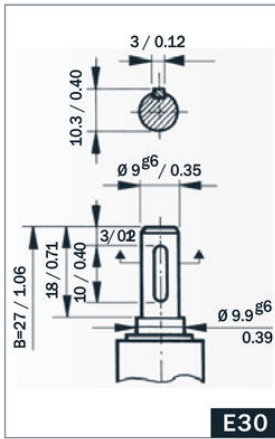

E30

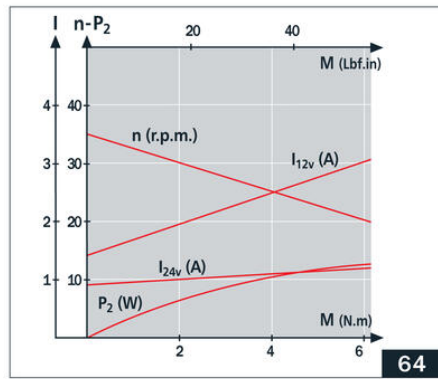

64

