

LCD HOURS RUN METER, CODIX 134-135

6.134.012.850

CODIX 134 HOURS COUNTER 0... 0.7 V DC

- Battery powered
- 99999h 59min or 99999.99h
- 7 Digit display
- PNP/NPN input



PRODUCT DESCRIPTION

Timer with 7-digit LCD display, 8 mm digit height. Built-in lithium battery with a service life of 8 years, available with background lighting (not kept in stock). Two models with different types in input for counting and reset. Zero potential closing contact or transistor input (NPN)/voltage for on and off. The counter has two selectable time ranges, 99999 h 59 m / 99999.99 h. The counter is reset either manually (using the button at the front) or electrically. The counter comes with clamps, gaskets and separate front frames to fit 25x50 mm panel holes. One for screw fitting and one without.

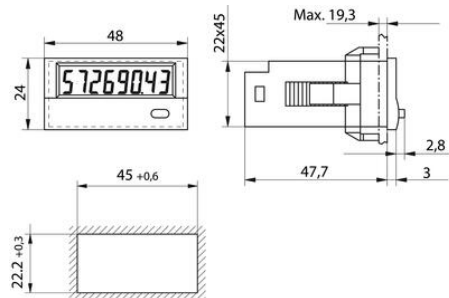
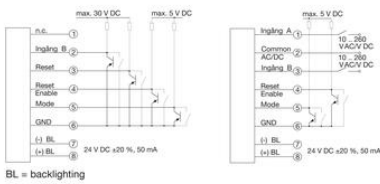

Frontram följer med räkaren

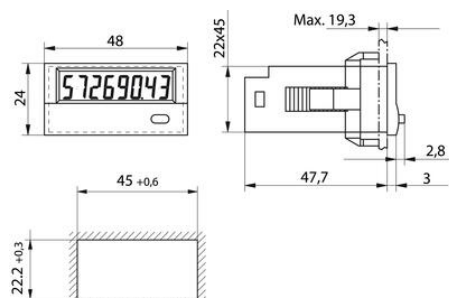
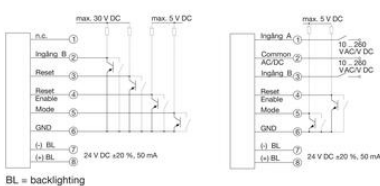
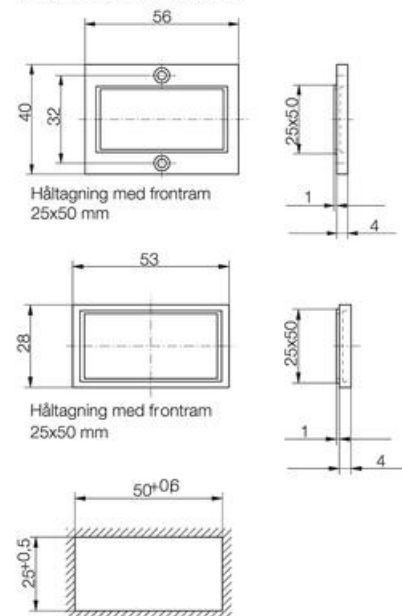

Frontram följer med räknaren

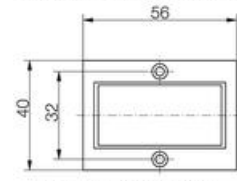

Håltagning med frontram
25x50 mm

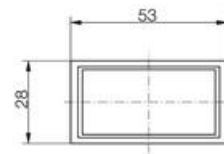
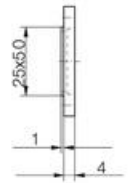

Håltagning med frontram
25x50 mm

